

Curaflex® Futterrohre 3000 Tubes fourreaux 3000 / Tubi fodera 3000

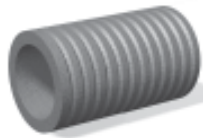

Curaflex® 3000

für Rohraussendurchmesser pour diam. ext. du tuyau passant per diam. est. del tubo passante		1-40	41-57	58-77	78-104	105-145
DN Futterrohr oder Ø Kenbohrung DN tube fourreau o diam. carottage [mm] DN tubo fodera o Ø carotaggio		80	100	125	150	200

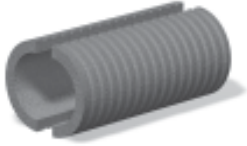

Curaflex® 3000/T

Preise auf Anfrage, prix sur demande, prezzi a richiesta

L = 200/250	62.40	94.50	114.60	123.70	144.80
300	71.40	103.60	121.70	133.70	155.80
350/400	90.50	120.60	141.80	157.80	177.90
500	105.60	138.70	170.90	190.00	220.10

Schnittkosten / frais de coupage / spese di taglio	15.10	15.10	17.10	17.10	24.20
----------------------------------------------------	-------	-------	-------	-------	-------

1701 Schalungshalterungen / attaches / supporti	4.10	5.10	8.10	12.10	14.10
-------------------------------------------------	------	------	------	-------	-------

Curaflex® Dichtungseinsätze mit DPS* Garnitures Curaflex® avec DPS / Guarnizioni Curaflex® con DPS



Curaflex® C

für Rohraussendurchmesser pour diam. ext. du tuyau passant [mm] per diam. est. del tubo passante	1-24	1-40	41-57	58-77	78-104	105-145
DN Futterrohr oder Ø Kenbohrung DN tube fourreau o diam. carottage [mm] DN tubo fodera o Ø carotaggio	50	80	100	125	150	200
Curaflex® C						
Mat.: ggV, galvanisé, galvanizzato	133.70	142.80	178.90	216.10	253.30	339.70
Mat.: Inox V2A (1.4301)	186.00	198.00	216.10	265.40	349.80	455.30
Mat.: Inox V4A (1.4571)	205.10	219.10	243.30	314.60	391.00	506.60

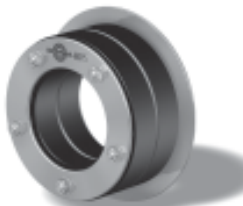

Curaflex® FZS

Curaflex® FZS (Zivilschutz / Protection civile / Protezione civile)						
für Rohraussendurchmesser pour diam. ext. du tuyau passant [mm] per diam. est. del tubo passante	1-24	1-40	41-57	58-77	78-104	105-115
Mat.: Inox V2A (1.4301)	-----	221.10	299.50	338.70	449.30	600.00



Curaflex® A

Curaflex® A						
Mat.: ggV, galvanisé, galvanizzato	87.50	92.50	102.60	128.70	152.80	194.00
Mat.: Inox V2A (1.4301)	118.60	125.70	147.80	186.00	226.20	290.50
Mat.: Inox V4A (1.4571)	130.70	147.80	168.90	203.10	250.30	340.70



Curaflex® BEx

Curaflex® B/Ex - Explosionsschutz - - protection contre les explosions - protezione						
Mat.: ggV, galvanisé, galvanizzato	102.60	110.60	123.70	159.80	194.00	248.30
Mat.: Inox V2A (1.4301)	154.80	163.90	208.10	260.30	316.60	422.10
Mat.: Inox V4A (1.4571)	184.00	190.00	260.30	335.70	422.10	530.70

*) DPS bis DN 350 / DPS jusqu'à DN 350 / DPS fina a DN 350

146-190	191-233	234-288	289-339	340-380	381-430	431-530	531-620
250	300	350	400	450	500	600	700

L = 200/250	173.90	220.10	240.20	292.50	346.80	372.90	503.60	609.10
300	187.00	235.20	266.40	318.60	397.60	411.10	557.80	702.50
350/400	212.10	296.50	307.60	396.00	484.50	538.70	669.40	884.40
500	262.40	352.80	367.90	472.40	585.00	646.30	789.00	1073.40

27.20	31.20	36.20	43.30	45.30	63.40	90.50	112.60
-------	-------	-------	-------	-------	-------	-------	--------

16.10	22.20	31.20	45.30	nicht lieferbar, non livrable, non fornibile			
-------	-------	-------	-------	----------------------------------------------	--	--	--

WICHTIG !

Für die Ausführung Ihrer Bestellung benötigen wir die folgenden Angaben:

- Rohr- oder Kabel-Aussendurchmesser d [mm] (! nicht DN)

IMPORTANT !

Pour l'exécution de votre commande nous avons besoins des indications suivantes:

- Diamètre extérieur du tuyau ou câble d [mm] (! pas le DN)

IMPORTANTE !

Per l'esecuzione della vs. commanda abbiamo bisogno degli indicazioni seguenti:

- Diametro esterno del tubo o del cavo d [mm] (! non il DN)

146-190	191-233	234-288	289-339	340-380	381-430	431-530	531-620
250	300	350	400	450	500	600	700

Curaflex® C

444.30	574.90	700.50	896.50	1107.60	1239.20	1736.70	2587.90
612.10	849.30	1113.60	1427.10	1978.90	2358.80	3479.30	4963.70
695.50	934.70	1201.00	1746.70	2386.90	2727.60	3937.60	5690.80

--	--	--	--	--	--	--	--

Curaflex® A

240.20	361.80	430.20	571.90	675.40	775.90		
371.90	501.50	783.90	1122.60	1374.90	1722.60		
462.30	618.10	937.70	1264.30	1667.30	1973.90		

contro le esplosioni

Curaflex® B/Ex

314.60	451.30	569.90	756.80	887.50	967.90		
595.00	847.30	1160.80	1459.30	1914.60	2305.50		
767.90	1269.40	1417.10	1894.50	2300.50	2550.70		

Curaflex® Dichtungseinsätze Quick In C und A mit DPS* aufklappbar
Garnitures Curaflex® Quick In C et A avec DPS* relevables
Guarnizioni Curaflex® Quick In C e A con DPS* apribile



Curaflex® Quick In C



Curaflex® Quick In A

für Rohraussendurchmesser pour diam. ext. du tuyau passant [mm] per diam. est. del tubo passante	1-24	1-40	41-57	58-77	78-104	105-145
DN Futterrohr oder Ø Kenbohrung DN tube fourreau o diam. carottage [mm] DN tubo fodera o Ø carotaggio	50	80	100	125	150	200
Curaflex® Quick In C	159.80	168.90	194.00	234.20	289.50	366.90
Curaflex® Quick In A	118.60	128.70	142.80	186.00	226.20	299.50

Ab Futterrohr/Kernbohrung DN 600 wird eine geteilte Ausführung geliefert.
 Supérieur au DN 600 du tube fourreau ou carottage en exécution divisée.
 Dal DN 600 del tubo fodera o carotaggio in esecuzione divisa.

Curaflex® Blind-Dichtungseinsätze mit DPS*
Bouchon Curaflex® avec DPS*
Tappo Curaflex® con DPS*



Curaflex® C/0

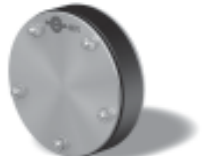

Curaflex® A/0

DN Futterrohr oder Ø Kenbohrung DN tube fourreau o diam. carottage [mm] DN tubo fodera o Ø carotaggio	50	80	100	125	150	200
Curaflex® C/0	157.80	168.90	203.10	301.50	349.80	441.20
Curaflex® D/0	168.90	175.90	213.10	319.60	369.90	465.40
Curaflex® F/0	168.90	175.90	213.10	319.60	369.90	465.40
Curaflex® A/0	94.50	104.60	115.60	170.90	203.10	250.30
Curaflex® B/0	107.60	113.60	125.70	186.00	224.20	274.40

Curaflex® Dichtungseinsätze C/2/SD/6 u. 5 bzw. F/2/SD 6 u. 5 mit DPS*
Garnitures Curaflex® C/2/SD/6 et 5 resp.. F/2/SD 6 et 5 avec DPS*
Guarnizioni Curaflex® C/2/SD/6 e 5 risp. F/2/SD 6 e 5 con DPS*

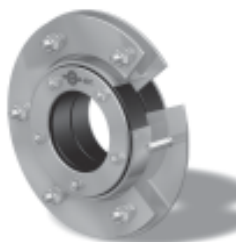

Curaflex® C/2/SD/6



Curaflex® C/2/SD/5

für Rohraussendurchmesser pour diam. ext. du tuyau passant [mm] per diam. est. del tubo passante		1-40	41-57	58-77	78-104	105-145
DN Futterrohr oder Ø Kenbohrung DN tube fourreau o diam. carottage [mm] DN tubo fodera o Ø carotaggio		80	100	125	150	200
Curaflex® C/2/SD/6**, F/2/SD/6**		727.70	819.10	917.60	997.00	1255.30
C/2/SD/6. F/2/SD/6**, besandet, sablé, insabbiato	auf	Anfrage				
1775 (2 Stück, 2 pièces, 2 pezzi)		112.60	119.60	128.70	150.80	174.90
Curaflex® C/2/SD/5**, F/2/SD/5		405.10	465.40	529.70	617.10	761.80
C/2/SD/5, F/2/SD/5**, besandet, sablé, insabbiato	auf	Anfrage				
1775 (2 Stück, 2 pièces, 2 pezzi)		75.40	78.40	78.40	86.50	93.50

*) DPS bis DN 350 / DPS jusqu'à DN 350 / DPS fin a DN 350

***) inkl. Dübel und Schrauben, y compris chevilles et vis, comprese tasselli e viti

146-190	191-233	234-288	289-339	340-380	381-430	431-530	531-620
250	300	350	400	450	500	600	700
479.40	636.20	753.80	953.80	1180.90	1349.80	2643.15	3949.65
371.90	526.70	600.00	794.00	934.70	1078.40	-----	-----



Curaflex® Quick In A / C \geq DN 600

250	300	350	400	450	500	600	700
638.20	832.20	1102.50	1501.50	1750.80	1962.80		
672.40	884.40	1208.10	1650.30	1923.60	2115.60	3495.40	4229.10
672.40	884.40	1208.10	1650.30	1923.60	2115.60	3495.40	4229.10
356.80	496.50	627.20	867.40	1078.40	1234.20		
391.00	546.80	731.70	1009.10	1241.20	1375.90	2555.80	3184.90

146-190	191-233	234-288	289-339	340-380	381-430	431-530
250	300	350	400	450	500	600
1455.30	1736.70	2108.50	2653.20	3966.80	4274.30	5100.40

204.10	232.20	258.30	282.50	311.60	337.70	427.20
896.50	1133.70	1336.70	1676.40	2205.00	2509.50	3495.40

101.60	112.60	128.70	142.80	153.80	174.90	250.30

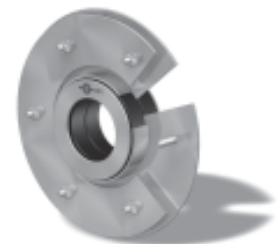

Curaflex® F/2/SD/6

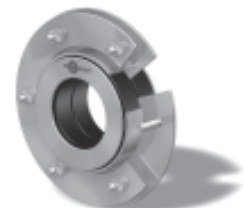

Curaflex® F/2/SD/5

Curaflex® Dichtungseinsätze C 40 und A40 mit DPS*

Garnitures Curaflex® C40 et A40 avec DPS*

Guarnizioni Curaflex® C40 e A40 con DPS*

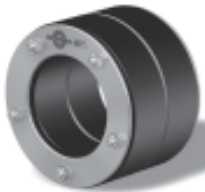

Curaflex® C40



Curaflex® A40

für Rohraussendurchmesser pour diam. ext. du tuyau passant [mm] per diam. est. del tubo passante	58-77	78-104	105-145	146-190	191-233	234-288	289-339
DN Futterrohr oder Ø Kenbohrung DN tube fourreau o diam. carottage [mm] DN tubo fodera o Ø carotaggio	125	150	200	250	300	350	400
Curaflex® C 40	231.20	279.40	371.90	479.40	620.10	741.70	941.70
Curaflex® A 40	142.80	173.90	224.20	281.40	399.00	455.30	600.00

*) DPS bis DN 350 / DPS jusqu'à DN 350 / DPS fin a DN 350

Diese Dichtungseinsätze sind ideal für Kunststoffmantelrohre.

Ces garnitures sont adaptées aux tubes fourreaux en plastique.

Queste guarnizioni sono specialmente per tubi di guaina in plastica.

Curaflex® Dichtungseinsätze C/S und A/S mit DPS* für abweichende Kernbohrungen

Garnitures Curaflex® C/S et A/S avec DPS* pour des carottages divergents

Guarnizioni Curaflex® C/S e A/S con DPS* per carotaggi aberranti



Curaflex® C/S



Curaflex® A/S

für Rohraussendurchmesser pour diam. ext. du tuyau passant [mm] per diam. est. del tubo passante	9-40	58-65	40-57	58-77	58-77	78-104	78-104	105-145	158-190
DN Futterrohr oder Ø Kenbohrung DN tube fourreau o diam. carottage [mm] DN tubo fodera o Ø carotaggio	100	100	125	130	150	160	200	250	300
Curaflex® C/S	226.20	229.20	323.70	279.40	366.90	334.70	491.50	645.30	832.20
Curaflex® A/S	123.70	128.70	194.00	170.90	216.10	208.10	276.40	351.80	524.70

Weitere Größen auf Anfrage.

Autres dimensions sur demande.

Altre dimensioni a richiesta.

Curaflex® Dichtungseinsätze MS/C und MS/A mit DPS*

Garnitures Curaflex® MS/C et MS/A avec DPS*

Guarnizioni Curaflex® MS/C e MS/A con DPS*



Curaflex® MS/C



Curaflex® MS/A

für Rohraussendurchmesser pour diam. ext. du tuyau passant [mm] per diam. est. del tubo passante	20-39	40-50	40-50	51-95	96-147	96-150	151-204	200-290
DN Futterrohr oder Ø Kenbohrung DN tube fourreau o diam. carottage [mm] DN tubo fodera o Ø carotaggio	100	100	125	150	200	250	300	400
Curaflex® MS/C								
Mat.: ggV, galvanisé, galvanizzato	205.10	205.10	245.30	299.50	406.10	565.90	806.10	1180.90
Mat.: Inox V2A (1.4301)	311.60	311.60	369.90	467.40	586.00	767.90	1159.80	1711.60
Mat.: Inox V4A (1.4571)	380.90	380.90	464.40	554.80	676.40	871.40	1288.50	2015.10
Curaflex® MS/A								
Mat.: ggV, galvanisé, galvanizzato	130.70	130.70	164.90	199.00	263.40	354.80	590.00	881.40
Mat.: Inox V2A (1.4301)	213.10	213.10	260.30	314.60	402.00	527.70	812.10	1420.10
Mat.: Inox V4A (1.4571)	234.20	234.20	280.40	349.80	462.30	638.20	971.90	1555.80

Für flexible Mantelrohre.

Pour des tubes fourreaux flexibles.

Per tubi fodera flessibili.

Curaflex® Dichtungseinsätze C/M und A/M mit DPS für mehrere Rohre/Kabel
Garnitures Curaflex® C/M et A/M avec DPS*, pour plusieurs tubes/câbles
Guarnizioni Curaflex® C/M e A/M con DPS*, per parecchi tubi/cavi



Curaflex® C/M



Curaflex® A/M

Ø aussen Rohr/Kabel Ø ext. tube/câble [mm] Øest. tubo/cavo	Anzahl Leitungen Nombre conduits Numero condotte	D Futterrohr / Kernbohrung D tube fourreau / carottage D tubo foder / carotaggio	Curaflex® C/M			Curaflex® A/M		
			ggv	V2A	V4A	ggv	V2A	V4A
1 - 14	1 - 2	50	172.90	253.30	270.40	119.60	175.90	186.00
1 - 26	1 - 2	80	177.90	263.40	280.40	124.70	186.00	200.00
1 - 23	1 - 3		228.20	338.70	354.80	154.80	224.20	239.20
1 - 24	1 - 4		250.30	378.90	395.00	177.90	263.40	278.40
1 - 16	1 - 7		316.60	451.30	470.40	254.30	378.90	391.00
1 x 4 - 32 1 x 1 - 14	2		177.90	263.40	280.40	124.70	186.00	200.00
4 x 4 - 28 1 x 1 - 12	1 - 5	100	289.50	425.20	455.30	204.10	304.60	323.70
1 - 21	1 - 7		328.70	477.40	501.50	246.30	354.80	371.90
4 - 37	1 - 2		220.10	323.70	340.70	154.80	224.20	239.20
4 - 33	1 - 3		236.20	351.80	378.90	177.90	245.30	263.40
1 x 4 - 46 1 x 1 - 16	2	125	225.20	330.75	348.80	159.80	231.20	246.30
4 - 36	1 - 4		300.50	451.30	477.40	228.20	335.70	359.80
2 x 4 - 34 2 x 4 - 42	1 - 4		300.50	451.30	477.40	228.20	335.70	359.80
4 - 28	1 - 7	150	375.90	556.80	577.90	300.50	434.20	455.30
4 - 41	1 - 3		275.40	416.10	447.30	208.10	300.50	329.70
2 x 23 - 51 2 x 8 - 36	1 - 4	200	405.10	605.10	642.20	249.30	369.90	394.00
2 x 30 - 58 2 x 13 - 41	1 - 4		405.10	605.10	642.20	249.30	369.90	394.00
4 x 22 - 50 1 x 4 - 16	1 - 5		422.10	636.20	673.40	266.40	402.00	425.20
1 - 20	1 - 13	250	546.80	894.50	937.70	375.90	600.00	688.50
6 x 8 - 36 2 x 4 - 16	1 - 8		462.30	765.90	806.10	336.70	499.50	556.80
43 - 71	1 - 3	200	530.70	797.00	847.30	298.50	439.20	470.40
5 x 23 - 51 1 x 4 - 31	1 - 6		575.90	856.30	908.60	350.80	525.70	556.80
2 x 28 - 56 2 x 54 - 82	1 - 4		519.60	778.90	826.20	319.60	472.40	501.50
40 - 69	1 - 4	250	519.60	778.90	826.20	319.60	472.40	501.50
4 - 36	1 - 10		621.10	928.70	983.90	405.10	605.10	642.20
4 - 26	1 - 15	200	716.60	1072.40	1139.70	525.70	787.00	834.20
8 x 13 - 41 4 x 4 - 30	1 - 12		666.40	995.00	1050.30	449.30	668.40	707.60
4 - 26	1 - 20	250	977.90	1285.40	1371.90	716.60	944.70	1005.00
12 - 40	1 - 8		787.00	1100.50	1155.80	566.90	823.10	866.40
10 x 16 - 44 5 x 4 - 36	1 - 15		887.50	1204.00	1290.50	632.20	861.30	923.60

Curaflex® Dichtungseinsätze C/M/T und A/M/T mit DPS, für mehrere Rohre/Kabel
Garnitures Curaflex® C/M/T et A/M/T avec DPS*, pour plusieurs tubes/câbles
Guarnizioni Curaflex® C/M/T e A/M/T con DPS*, per parecchi tubi/cavi



Curaflex® C/M/T

Ø aussen Rohr/Kabel Ø ext. tube/câble [mm] Øest. tubo/cavo	Anzahl Leitungen Nombre conduits Numero condotte	D Futterrohr / Kernbohrung D tube fourreau / carottage D tubo foder / carotaggio	Curaflex® C/M/T ggv	Curaflex® A/M/T ggv
1 - 22	1 - 3	80	265.40	186.00
4 - 37	1 - 2	100	274.40	205.10
4 - 26	1 - 4		350.80	245.30
1 x 20 - 36 2 x 8 - 16	1 - 3		311.60	225.20
1 x 8 - 22 4 x 8 - 16	1 - 5	125	389.00	265.40
4 - 34	1 - 4		391.00	274.40
25 - 41	1 - 3	150	353.80	251.30
2 x 2 - 48 2 x 2 - 38	1 - 4		426.20	299.50
15 - 31	1 - 9	200	721.60	466.40

Curaflex® Kombinationen 3000 für Bauten ohne Dichtungsbahnen

Combinaisons Curaflex® 3000 pour constructions sans bandes d'étanchéités

Combinazioni Curaflex® 3000 per costruzioni senza telo d'impermeabilizzazione

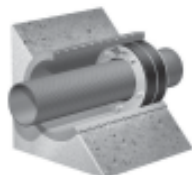

für Rohraussendurchmesser pour diam. ext. du tuyau passant [mm] per diam. est. del tubo passante			1-40	41-57	58-77	78-104	105-145
DN Futterrohr oder Ø Kenbohrung DN tube fourreau o diam. carottage [mm] DN tubo fodera o Ø carotaggio			80	100	125	150	200
Länge, longueur, lunghezza [mm]							
Curaflex® 3300	200 / 250		205.10	273.40	330.70	376.90	484.50
	300		214.10	282.50	337.70	387.00	495.50
	350 / 400		233.20	299.50	357.80	411.10	517.60
	500		248.30	317.60	387.00	443.30	559.80



für Rohraussendurchmesser pour diam. ext. du tuyau passant [mm] per diam. est. del tubo passante		1-24	1-40	41-57	58-77	78-104	105-115
Länge, longueur, lunghezza [mm]							
Curaflex® 3600/ZS	200 / 250		283.50	394.00	453.30	572.90	744.80
	300		292.50	403.10	460.30	582.90	755.80
	350 / 400		311.60	420.10	480.40	607.10	777.90
	500		326.70	438.20	509.60	639.20	820.10



Länge, longueur, lunghezza [mm]							
Curaflex® 3300/T	200 / 250		253.30	314.60	392.00	458.30	561.80
	300		265.40	329.70	405.10	474.40	578.90
	350 / 400		292.50	355.80	441.20	514.60	619.10
	500		315.60	384.00	486.50	563.90	679.40

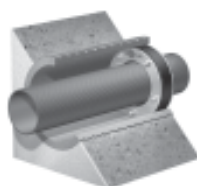

Länge, longueur, lunghezza [mm]							
Curaflex® 3100	200 / 250		154.80	197.00	243.30	276.40	338.70
	300		163.90	206.10	250.30	286.50	349.80
	350 / 400		183.00	223.20	270.40	310.60	371.90
	500		198.00	241.20	299.50	342.80	414.10

Für die Ausführung Ihrer Bestellung benötigen wir die folgenden Angaben:

- Rohr- oder Kabel-Aussendurchmesser d [mm] (! nicht DN)
- Baulänge (= Mauerstärke) L [mm]

Pour l'exécution de votre commande nous avons besoins des indications suivantes:

- Diamètre extérieur du tuyau ou câble d [mm] (! pas le DN)
- Longueur (= épaisseur de mur) L [mm]

Per l'esecuzione della vs. commanda abbiamo bisogno degli indicazioni seguenti:

- Diametro esterno del tubo o del cavo d [mm]
- Lunghezza (= spessore muro) L [mm] (! non il DN)

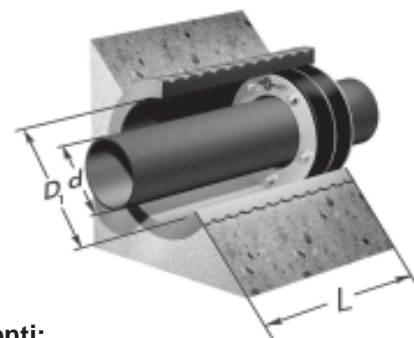

	für Rohraussendurchmesser pour diam. ext. du tuyau passant [mm] per diam. est. del tubo passante	146-190	191-233	234-288	289-339	340-380	381-430	431-530	531-620
	DN Futterrohr oder Ø Kenbohrung DN tube fourreau o diam. carottage[mm] DN tubo fodera o Ø carotaggio	250	300	350	400	450	500	600	700
Länge, longueur, lunghezza [mm]									
Curaflex® 3300	200 / 250	618.10	795.00	940.70	1189.00	1454.30	1612.10	2240.20	3197.00
	300	631.20	810.10	966.90	1215.10	1475.40	1650.30	2294.50	3290.40
	350 / 400	656.30	871.40	1008.10	1292.50	1592.00	1777.90	2406.00	3472.30
	500	706.60	927.70	1068.40	1368.90	1692.50	1885.40	2525.60	3660.30

Länge, longueur, lunghezza [mm]							
Curaflex® 3300/T	200 / 250	703.50	907.60	1074.40	1337.70	1650.30	1872.40
	300	723.60	939.70	1111.60	1376.90	1699.50	1941.70
	350 / 400	767.90	1014.10	1183.90	1490.50	1863.30	2129.60
	500	837.20	1091.50	1273.40	1600.00	2012.10	2296.50

Länge, longueur, lunghezza [mm]							
Curaflex® 3100	200 / 250	414.10	581.90	670.40	864.30	1022.10	1148.80
	300	427.20	597.00	696.50	890.50	1043.20	1187.00
	350 / 400	452.30	658.30	737.70	967.90	1159.80	1314.60
	500	502.50	714.60	798.00	1044.20	1260.30	1422.10

Abb.: Curaflex® 4300 eingebaut in der Bodenplatte
Illustration: Curaflex® 4300 pose dans la dalle de fond
Illustrazione: Curaflex® 4300 posato nel plinto di fondazione



Abb.: Curaflex® 3300 eingebaut in der Bodenplatte
Illustration: Curaflex® 3300 pose dans la dalle de fond
Illustrazione: Curaflex® 3300 posato nel plinto di fondazione



Curaflex® Kombinationen 4000 für Bauten mit Dichtungsbahnen
Combinaisons Curaflex® 4000 pour constructions avec bandes d'étanchéités
Combinazioni Curaflex® 4000 per costruzioni con telo d'impermeabilizzazione

für Rohraussendurchmesser pour diam. ext. du tuyau passant [mm] per diam. est. del tubo passante		1-40	41-57	58-77	78-104	105-145	146-190	191-233
DN Futterrohr oder Ø Kenbohrung DN tube fourreau o diam. carottage [mm] DN tubo fodera o Ø carotaggio		80	100	125	150	200	250	300
Länge, longueur, lunghezza [mm]								
Curaflex® 4006 Futterrohr tube fourreau tubo fodera	200 / 250	5146.0	644.30	732.70	782.90	913.60	1016.10	1220.10
	300	524.70	657.30	743.70	796.00	954.80	1055.30	1262.30
	350 / 400	540.70	673.40	759.80	813.10	998.00	1098.50	1292.50
	500	557.80	691.50	772.90	833.20	1044.20	1145.70	1330.70

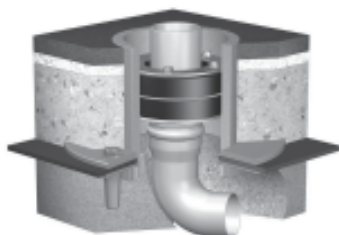
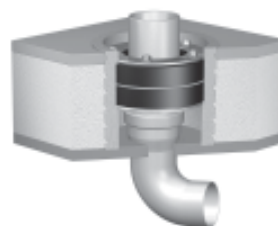
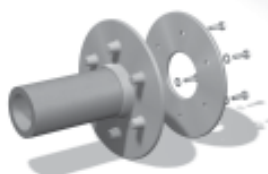

Länge, longueur, lunghezza [mm]								
Curaflex® 4300	200 / 250	657.30	823.10	948.80	1036.20	1253.30	1460.30	1795.00
	300	667.40	836.20	959.80	1049.30	1294.50	1499.50	1837.20
	350 / 400	683.40	852.30	975.90	1066.40	1337.70	1542.70	1867.30
	500	700.50	870.40	989.00	1086.50	1383.90	1590.00	1905.50

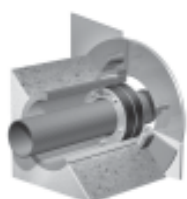

für / pour / per Curaflex® 4300 / 4110

1775 Zulagen, joints plats, guarnizioni piatte	150.80	153.80	166.90	174.90	208.10	232.20	258.30
------------------------------------------------	--------	--------	--------	--------	--------	--------	--------

Länge, longueur, lunghezza [mm]								
Curaflex® 4005 Futterrohr tube fourreau tubo fodera	200 / 250	385.00	425.20	534.70	566.90	623.10	686.50	1044.20
	300	396.00	434.20	545.80	580.90	663.30	727.70	1073.40
	350 / 400	414.10	448.30	557.80	601.00	704.60	767.90	1110.60
	500	427.20	466.40	568.90	621.10	743.70	810.10	1142.70

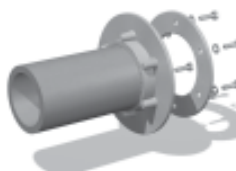

Länge, longueur, lunghezza [mm]								
Curaflex® 4100	200 / 250	477.40	527.70	663.30	719.60	817.10	926.70	1406.00
	300	488.50	536.70	674.40	733.70	857.30	967.90	1435.20
	350 / 400	506.60	550.80	686.50	753.80	898.50	1008.10	1472.40
	500	519.60	568.90	697.50	773.90	937.70	1050.30	1504.50

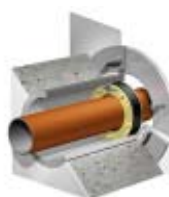

für / pour / per Curaflex® 4100

1775 Zulagen, joints plats, guarnizioni piatte	71.40	75.40	86.50	88.50	101.60	116.60	128.70
------------------------------------------------	-------	-------	-------	-------	--------	--------	--------

Curaflex® Kombinationen mit Stahlfutterrohren
Combinaisons Curaflex® avec tubes fourreaux en acier
Combinazioni Curaflex® con tubi fodera in acciaio



Curaflex® 6300

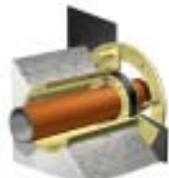

Curaflex® 5100

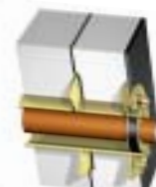

Curaflex® 5.5102

Curaflex® Kombinationen 7000 für Bauten mit Dichtungsbahnen
Combinaisons Curaflex® 7000 pour constructions avec bandes d'étanchéités
Combinazioni Curaflex® 7000 per costruzioni con telo d'impermeabilizzazione

für Rohraussendurchmesser pour diam. ext. du tuyau passant [mm] per diam. est. del tubo passante		1-40	41-57	58-77	78-104	105-145
DN Futterrohr oder Ø Kenbohrung DN tube fourreau o diam. carottage [mm] DN tubo fodera o Ø carotaggio		80	100	125	150	200



Curaflex® 7300

Curaflex® 7300		983.90	1093.50	1229.20	1332.70	1615.10
1775 Zulagen, joints plats, guarnizioni piate		196.00	211.10	228.20	260.30	289.50



Curaflex® 7300/T

Curaflex® 7300/T** , geteilt, partagé, bipartito		1223.10	1339.70	1479.40	1616.10	1892.50
1775 Zulagen, joints plats, guarnizioni piate		277.40	293.50	315.60	337.70	392.00
Dichtungsmittel, Produit d'étanchéité, Prodotto di tenuta		127.70	127.70	127.70	127.70	127.70



Curaflex® 7100

Curaflex® 7100**		502.50	578.90	629.20	685.50	794.00
1775 Zulagen, joints plats, guarnizioni piate		88.50	95.50	101.60	128.70	150.80

Curaflex® Kombinationen 8000 für Bauten ohne Dichtungsbahnen
Combinaisons Curaflex® 8000 pour constructions sans bandes d'étanchéités
Combinazioni Curaflex® 8000 per costruzioni senza telo d'impermeabilizzazione

für Rohraussendurchmesser pour diam. ext. du tuyau passant [mm] per diam. est. del tubo passante		1-40	41-57	58-77	78-104	105-145
DN Futterrohr oder Ø Kenbohrung DN tube fourreau o diam. carottage [mm] DN tubo fodera o Ø carotaggio		80	100	125	150	200



Curaflex® 8300

Curaflex® 8300		434.20	484.50	537.70	590.00	731.70
-----------------------	--	--------	--------	--------	--------	--------



Curaflex® 8300/T

Curaflex® 8300/T		673.40	731.70	789.00	872.40	1009.10
-------------------------	--	--------	--------	--------	--------	---------



Curaflex® 8100

Curaflex® 8100		384.00	408.10	450.30	489.50	586.00
Dichtungsmittel, Produit d'étanchéité, Prodotto di tenuta		127.70	127.70	127.70	127.70	127.70

*) DPS bis DN 350 / DPS jusqu'à DN 350 / DPS fin a DN 350

***) inkl. Dübel und Schrauben, y compris chevilles et vis, comprese tasselli e viti

für Rohraussendurchmesser pour diam. ext. du tuyau passant [mm] per diam. est. del tubo passante	146-190	191-233	234-288	289-339	340-380	381-430
DN Futterrohr oder Ø Kenbohrung DN tube fourreau o diam. carottage [mm] DN tubo fodera o Ø carotaggio	250	300	350	400	450	500

Curaflex® 7300	1873.40	2227.10	2680.40	3099.50	3593.90	4012.00
1775 Zulagen, joints plats, guarnizioni piatte	334.70	385.00	427.20	458.30	508.60	577.80

Curaflex® 7300/T** , geteilt, partagé, bipartito	2190.90	2601.00	3069.30	3460.30	3989.90	4508.45
1775 Zulagen, joints plats, guarnizioni piatte	443.30	486.50	533.70	593.00	644.30	691.50
Dichtungsmittel, Produit d'étanchéité, Prodotto di tenuta	127.70	127.70	127.70	127.70	127.70	127.70

Curaflex® 7100**	908.60	1105.5	1252.30	1508.60	1772.90	1970.90
1775 Zulagen, joints plats, guarnizioni piatte	169.90	204.10	228.20	258.30	289.50	289.45

für Rohraussendurchmesser pour diam. ext. du tuyau passant [mm] per diam. est. del tubo passante	146-190	191-233	234-288	289-339	340-380	381-430
DN Futterrohr oder Ø Kenbohrung DN tube fourreau o diam. carottage [mm] DN tubo fodera o Ø carotaggio	250	300	350	400	450	500

Curaflex® 8300**	865.40	1057.30	1250.30	1546.70	1861.30	2123.60
-------------------------	--------	---------	---------	---------	---------	---------

Curaflex® 8300/T**	1181.90	1432.20	1638.20	1907.50	2256.30	2623.10
---------------------------	---------	---------	---------	---------	---------	---------

Curaflex® 8100**	661.30	844.20	979.90	1222.10	1429.20	1660.30
Dichtungsmittel, Produit d'étanchéité, Prodotto di tenuta	127.70	127.70	127.70	127.70	127.70	127.70

Curaflex® Zubehör
Accessoires Curaflex®
Accessori Curaflex®



für Rohraussendurchmesser pour diam. ext. du tuyau passant [mm] per diam. est. del tubo passante	19-28	29-40	23-38	39-64	54-77	75-115	98-160
DN Futterrohr oder Ø Kenbohrung DN tube fourreau o diam. carottage [mm] DN tubo fodera o Ø carotaggio	80	80	100	100	125	150	200
Curaflex® 1708 Verschlussring, bague d'obturation, pezzo di chiusura	15.10	15.10	15.10	15.10	17.10	27.20	41.30



Steckchlüssel 1704 Clé à douille 1704 Chiave a bussola 1704 l = 800 mm	M 6
	50.30
	M 8
	58.30



AQUAGARD 1711/1716

- Grundierung und Speziallack 1/3 l
- Primeur et vernis de laque 1/3 l
- Primer e vernice lacca 1/3 l

Set CHF: 53.40

AQUAGARD 1710/1715

- Grundierung und Speziallack 1 l
- Primeur et vernis de laque 1 l
- Primer e vernice lacca 1 l

Set CHF: 114.70

Sikadur-31 (Curaflex® 1740)

- Betonkleber 1,2 kg für 0.7 m²
- Colle de béton pour 0.7 m²
- Colla di calcestruzzo per 0.7 m²

CHF: 128.70